

Article number: 204060M1028A1X

Description: E+G levelling foot

GN 40-60-M10-28-A1-X

Note: X With female thread, External hexagon

Measures

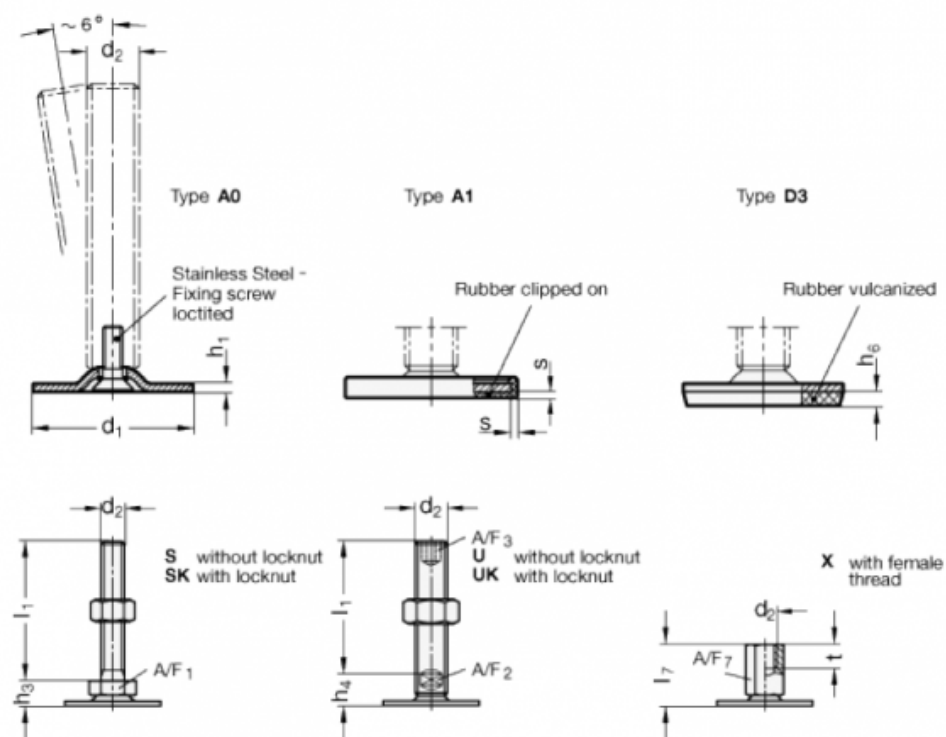

A/F7	= 14
d1	= 60
d2	= M10
h1	= 2.5
h6	=
l7	= 28
s	= 2
t	= 10